

Atwood
 1120 North Main Street • Elkhart, IN 46514
 PHONE: 574-264-2131 FAX: 574-206-9713
 INTERNET: http://www.atwoodmobile.com



Conforms to ANSI
 STD Z21.19a-2009
 Certified to CSA
 STD 2.14a-2009

LITERATURE NUMBER MPD 4003333
**RV REFRIGERATOR
 LP-GAS & ELECTRIC
 HE-0601, HE-0801**
 PROTECTED BY US PATENTS PENDING

SAFETY ALERT SYMBOLS

Safety Symbols alerting you to potential personal safety hazards.
 Obey all safety messages following these symbols

WARNING
 avoid possible injury or death

CAUTION
 avoid possible injury and/or property damage

**FOR YOUR SAFETY
 READ ALL INSTRUCTIONS BEFORE OPERATING APPLIANCE**

Installer: Provide these instructions to the consumer
Consumer: Keep these documents for future reference

**WARNING
 FIRE OR EXPLOSION**

**FOR YOUR SAFETY
 WHAT TO DO IF YOU SMELL GAS**

- * Open windows
 - * DO NOT TOUCH any electrical switch or use any phone or radio in vehicle
 - * Extinguish any open flame
 - * Evacuate ALL persons from vehicle
 - * Shut off gas supply at gas container or source
 - * DO NOT START vehicle's engine or electric generator
 - * Contact nearest gas supplier or qualified Service Technician for repairs
 - * If you cannot reach a gas supplier or qualified technician, contact the nearest fire department
- DO NOT turn on gas supply until gas leak(s) have been repaired

FOR YOUR SAFETY

* DO NOT store or use gasoline or other flammable vapors and liquids in the vicinity of this or any other appliance.

WARNING

* Improper installation, adjustment, service or maintenance can cause injury, property damage or death. Refer to this manual. For assistance or additional information, consult a qualified installer, service agency, manufacturer or the gas supplier.

**WARNING
 EXPLOSION OR FIRE**

- Shut off all gas appliances and pilot lights when refueling gasoline tanks or LP tanks
- Atwood refrigerators are for use with LP gas only and for installation in recreation vehicles only (e.g. travel trailers, motor homes, tent campers, etc.)

**WARNING
 CARBON MONOXIDE POISONING**

- Shut off all gas appliances and pilot lights when refueling gasoline tanks or LP tanks
- Atwood refrigerators are for use with LP gas only and for installation in recreation vehicles only (e.g. travel trailers, motor homes, tent campers, etc.)

Installation * Operation * Maintenance

Effective 1/15/2011

NOTE TO CONSUMER:

Have the installer or dealer show you where the main gas shut off valve is located so that you will know how and where to turn off the gas supply when necessary.

Table of Contents

Safety Information.....1
 Installation.....1-3
 Ventilation.....2-3
 Doors4-5
 Operation.....6-7
 Maintenance.....8-9
 Storage.....8
 Warranty.....9
 Wiring Diagram.....10

INSTALLATION

GENERAL INSTRUCTION

This appliance is designed for storage of foods and frozen foods and is certified under ANSI Z21.19 – CSA 1.4 Refrigerators using gas fuel.

This installation must conform with local codes, or in the absence of local codes, the following standards as applicable.

The US installation codes include:

1. National Fuel Gas Code, ANSI Z223.1/NFPA 54
2. Recreational Vehicles Code, ANSI A119.2
3. Manufactured Home Construction and Safety Standard, Title 24 CFR, Part 280.

A manufactured home (mobile home) installation must conform with the Manufactured Home Construction and Safety Standard, Title 24 CFR, Part 3280 [formerly the Federal Standard for Mobile Home Construction and Safety, Title 24 (Part 280) and current CSA Z240.4, Gas-equipped Recreational Vehicles and Mobile Home Housing.

If an external electrical source is utilized, the installed refrigerator must be electrically grounded in accordance with local codes including the edition of National Electrical Code, ANSI/ NFPA 70.

The Canadian installation codes include:

1. Natural Gas and Propane Installation Code, CSA B149.1
2. CSA Z240 RV Series, Recreational Vehicles
3. Current CSA Z240.4, Gas-equipped Recreational Vehicles and Mobile Housing.

If an external electrical source is utilized, the installed refrigerator must be electrically grounded in accordance with local codes including the latest edition of the Canadian Electrical Code, CSA C22.1, Parts I and II.

INSTALLING THE REFRIGERATOR INTO THE ENCLOSURE

1. Make sure that the height of the enclosure is between 59.875 and 60.125 inches for HE-08xx models or between 52.875 and 53.125 inches for HE-06xx models. The width of the enclosure must be between 23.50 and 23.65 inches. The depth of the enclosure should be at least 24.00 inches.
2. The floor must be solid and level and must be able to support the weight of the refrigerator and contents. Never install the refrigerator directly on carpeting.
3. When installing the refrigerator into the enclosure recess, all areas within the recess must be sealed to prevent exhaust fumes from entering the living space. Insure that the combustion seal is compressed between the front mounting flange of the refrigerator and all sides including the top and bottom of the enclosure. The bottom trim must be installed so that the mounting holes line up with the two holes in the bottom flange (Fig 12).
4. The refrigerator must be secured in place with four wood screws. Two screws secure the bottom flange and the bottom trim to the bottom of the enclosure and 2 screws secure the top flange to the top of the enclosure.



FIG 12

5. The refrigerator is certified to operate in an enclosure with zero clearance to combustible materials refrigerator as illustrated in Fig. 7 for the top (G), sides (K), bottom (L) and back (M) of the refrigerator.

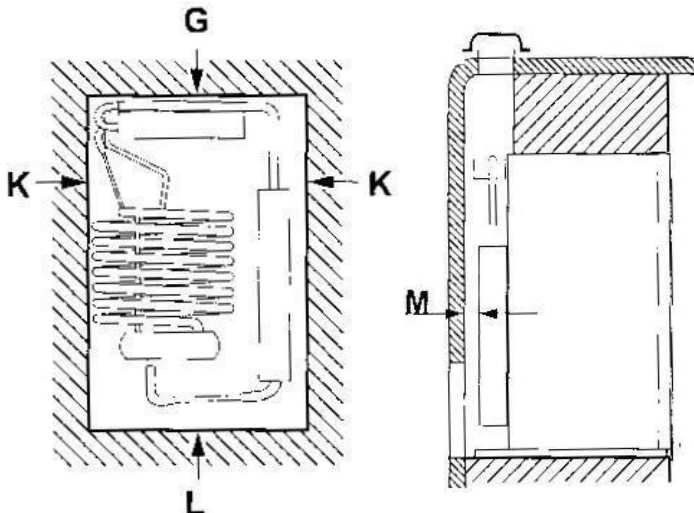

FIG 7

VENTILATION

Proper installation requires one lower fresh air intake vent and one upper exhaust vent. The ventilation kits for this refrigerator are certified for use with these models and must be installed exactly as written in this manual without modification. Any other installation method voids both the certification and the factory warranty of the refrigerator.

VENT CUTOUT DIMENSIONS (Rough Opening)

Upper Roof Vent Base	24" x 5 ¼ "
Side Vent Cutout Dims	13 ¾ " x 21 ½ "

INSTALLATION OF LOWER VENT

The bottom of the opening of the lower fresh air intake should be even with floor of the enclosure. With the lower vent in this position, it can provide a path for any leaking propane fumes to escape and not collect at the floor level. The center of the lower vent should be directly behind the center of the refrigerator as illustrated in Fig. 8.

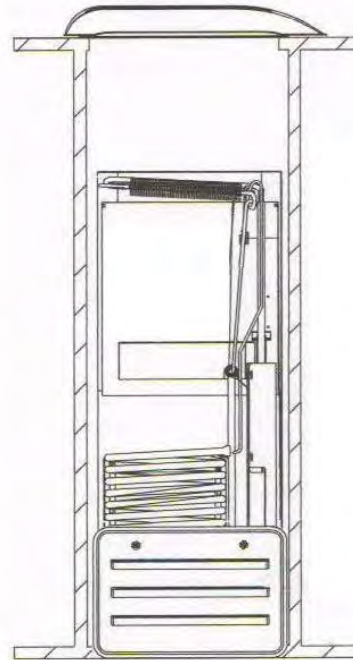

FIG 8

INSTALLATION OF UPPER ROOF VENT

The upper roof vent should be aligned directly above the refrigerator with a free and unobstructed path for the air flow rising up from the refrigerator's condenser.

Ideally the roof vent is installed directly above the condenser of the refrigerator as shown in Fig. 9. Other installations require the roof vent to be positioned more in the center of the vehicle which requires the construction of a special baffle to angle the air back to the roof vent as shown in Fig 10.

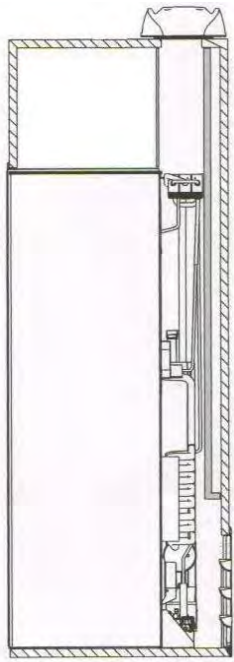

FIG 9

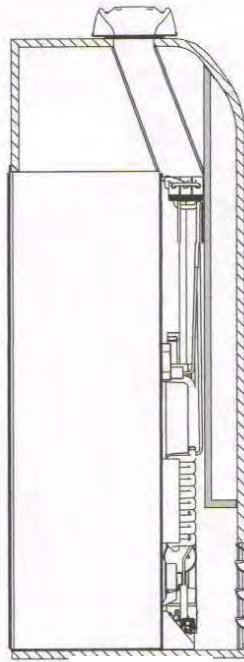

FIG 10

For installations where the depth of the enclosure is greater than 26 inches, additional baffling may be required to direct the airflow thru the absorber and condenser section of the refrigerator as shown in Fig 10.

The refrigerator must be positioned with respect to the upper roof vent so that a minimum ventilation height is achieved as illustrated in Fig 11. The minimum ventilation heights are:

Refrigerator	Min Ventilation Height
HE-06xx	57.75 in
HE-08xx	63.75 in

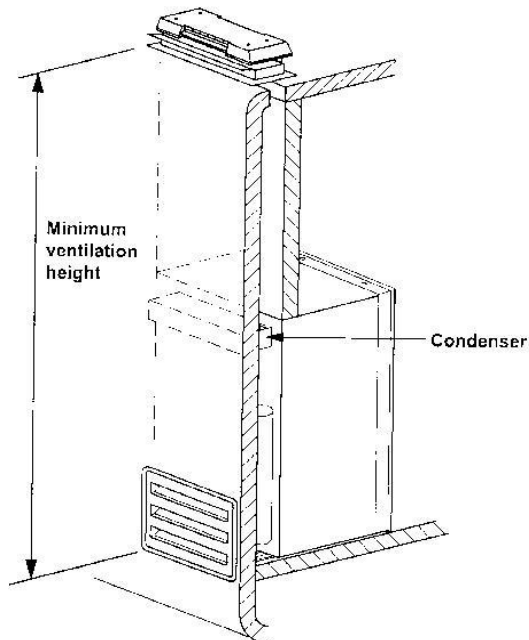

FIG 11

Slide-Out Applications

There are some vehicle applications, such as in slide-out configurations, where a roof vent is not practical. For those applications, the roof vent is replaced with an upper side vent as shown in Fig 14 and Fig 15 below. It is important to note that for these installations with restricted air flow, Atwood offers refrigerator models with a built-in external fan to insure that adequate ventilation is provided and to insure optimal cooling performance.

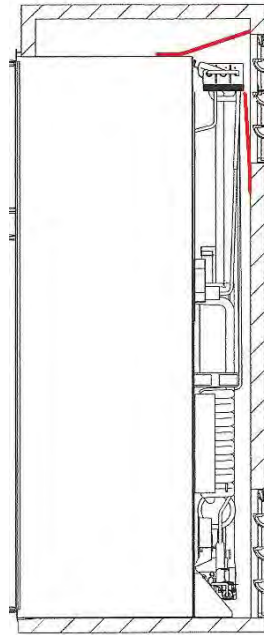

FIG 14

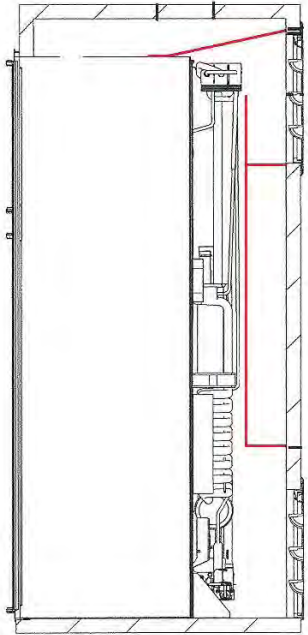

FIG 15

For installations with an enclosure depth of between 24" and 26", the installation is given in Fig 14. It is important to install the two baffle sections highlighted in red in the diagram. These baffles can be pieces of sheet metal which extend the entire width of the refrigerator cabinet. The main objective of these baffles is to force the ventilation air through the condenser fin section and to prevent hot air from collecting above the condenser and directing it out the upper side vent.

For installations with an enclosure depth greater than 26", the installation is given in Fig 15. Both baffle sections must be the entire width of the refrigerator cabinet. The lower box baffle (highlighted in red) forces the air from the lower side vent up through the absorber coils. It is very important that the top section of the lower box baffle extend up to within an inch of the lower corner of the condenser fin to insure that air is directed thru condenser section as well. The top baffle section can be made of sheet metal and must also extend the entire width of the cabinet. It's purpose is to prevent hot air from collecting above the condenser and directing it out the upper side vent.

DECORATIVE DOOR PANELS

The doors are designed to accept decorative door panels to match the kitchen décor. The decorative panels must be 0.187 inch or less in thickness. Door panels should be installed in the refrigerator doors before installing the refrigerator in the vehicle.

The upper door panel dimensions for both models are 21 – 1/2 inch wide by 14 - 11/16 inch tall.

The lower door panel dimensions for the HE-0601 are 21 – 1/2 inch wide by 31 – 1/4 inch tall.

The lower door panel dimensions for the HE-0801 are 21 – 1/2 inch wide by 37 - 15/16 inch tall.

To install the door panels, first pull the panel retainer off the side of each door. Push the door panel into the slots of the door and push the panel retainer back into place to hold the panel inside the door. See Fig 13.

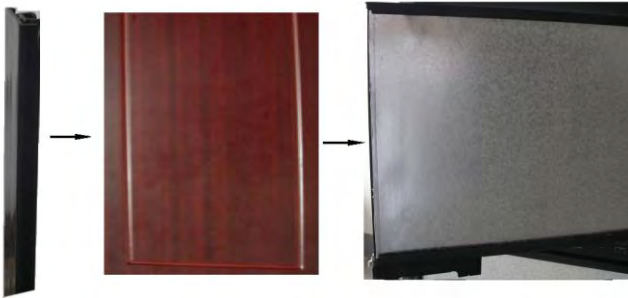

FIG 13

REVERSING THE DOOR SWINGS (OPTIONAL)

This refrigerator has been designed to allow for the door swings to be reversed using the following procedure.

1. Remove the storage bins from the doors
2. Remove the top hinge pin for the freezer door and lift the door off of its lower hinge. Remove the top hinge pin for the cabinet door and lift the door off of its lower hinge.
3. After the doors have been removed, remove the hinges keeping track of where each hinge and each hinge pin was originally installed (e.g. the top right corner hinge, the top middle hinge, top hinge pin, etc.)
4. Remove the door handle assemblies from the doors keeping track of where each door hinge was originally installed (e.g. freezer door handle, fresh food door handle).
5. On the refrigerator cabinet, remove the 3 screws holding the display panel housing onto the center divider section of the refrigerator.
6. Hold the display housing in your hand while disconnecting the wiring harness to the display board assembly and set the display housing aside.
7. Remove and save all the plastic screw hole caps on the center divider and in the hinge mounting holes on the other side of the cabinet.
8. Remove and remount the display board bracket and the latch plate as shown in Fig 6.
9. Pick up the display housing and observe the back of the display board assembly.
10. The display board assembly is held into the black display board housing by two tabs on either end of the display board assembly. Gently spread those tabs apart to allow the display board assembly to be pulled out the front of the display board housing.
11. Rotate the display board assembly 180 degrees and reinsert back into the display board housing making sure to snap the assembly back into the two tabs of the housing.
12. Reconnect the wiring harness to the display board assembly.
13. Rotate the display housing so the display is readable and remount the display board housing using the display board bracket and the three mounting screws.
14. Remove the hinge which was the top hinge for the freezer door and reinstall it on the other side of the cabinet as the new freezer bottom hinge.
15. Remove the lower hinge pin from the old freezer bottom hinge and reinstall it on the new freezer bottom hinge.
16. Remove the old freezer bottom hinge and reinstall it on the other side as the new freezer top hinge.
17. Remove the hinge which was top hinge for the cabinet door and reinstall it on the other side of the cabinet as the new cabinet bottom hinge.
18. Remove the lower hinge pin from the old cabinet bottom hinge and reinstall it on the new cabinet bottom hinge.
19. Remove the old cabinet bottom hinge and reinstall it on the other side as the new cabinet top hinge.
20. Reinstall all of the plastic screw hole caps in the mounting holes on the other side of the cabinet.
21. Turn the cabinet door upside down and mount the old freezer door handle assembly on the cabinet door's new top side.
22. Turn the freezer door upside down and mount the old cabinet door handle assembly on the freezer door's new top side.
23. Place the hinge side of the cabinet door onto the hinge pin which is pointing up from the bottom cabinet hinge. Push the top side of the cabinet door so that the hinge side of the top of the door is directly below the top cabinet hinge and insert the hinge pin to hold the door in place.
24. Place the hinge side of the freezer door up onto the hinge pin which is pointing down from the top freezer hinge. Push the bottom side of the freezer door so that the hinge side of the bottom of the door is directly above the bottom freezer hinge and screw in the hinge pin to hold the door in place.
25. Reinstall storage bins in doors as desired.



LATCH PLATE HOUSING BRACKET

RIGHT HINGED DOORS



HOUSING BRACKET LATCHPLATE

LEFT HINGED DOORS

FIG 6

ELECTRICAL CONNECTIONS

120 Volts AC Connection

This refrigerator is supplied with a 3-prong AC power cord which should be plugged into a properly grounded 3-prong receptacle. DO NOT use an extension cord or a 2-prong adapter with the power cord. NEVER cut or remove the grounding prong from the plug as this is provided for your safety. It is recommended that the receptacle be located to the left side of the back of the refrigerator, approximately 6 inch above the floor. The cord should be routed to avoid contact with any hot or sharp metal surfaces which could damage the cord's insulation.

The AC operating range is: 108 VAC – 132 VAC

12 Volts DC Connection

The refrigerator's electronic controls require 12 volt DC to operate. The DC supply lines should use a minimum of 18 gauge wire. The refrigerator connections require a insulated 1/4 inch female Quick Connect terminal to be applied to each DC supply wire. The positive DC power wire is connected to the power board terminal marked "+12in". The DC ground wire is connected to the power board terminal marked "GND". DO NOT use the chassis of the refrigerator or the vehicle as one of the conductors. Connect the two DC supply wires from the battery directly to the refrigerator.

The DC operating range is: +9.0 VDC - +15.0 VDC

GAS CONNECTIONS

All gas supply connections must comply with the ANSI A 119.2 (NFPA 1192) and CSA Z240 standards for Recreational Vehicles.

The gas supply system must incorporate a pressure regulator to maintain a supply pressure of 11 inches water column.

Atwood recommends using 3/8 inch copper tubing as the gas supply line. The gas supply line is connected to the refrigerator at the inlet of the gas safety valve which is a 3/8 inch SAE (UNF 5/8 -18) male flare fitting.

The gas supply line is pushed up thru a hole in the floor behind the refrigerator. The hole must be large enough to provide adequate clearance for the gas supply line and positioned such that the supply line is not rubbing against anything in the enclosure. A weather resistant grommet or seal should be installed around the gas supply line in the hole thru the floor to prevent vibration and abrasion.

Checking for gas supply system leaks

All gas supply system connections must be checked for leaks using soapy water.



WARNING

NEVER USE A FLAME TO CHECK FOR LEAKS

When using compressed air to check for leaks, the test pressure must be no more than 1/2 PSI (14 inches of water column).

TESTING THE GAS SAFETY VALVE

The gas safety valve must be tested after the refrigerator is connected to the gas supply.

1. Start the refrigerator in the manual GAS mode.
2. Open the lower fresh air intake vent located behind the refrigerator.
3. Verify that the refrigerator's burner is lit.
4. Remove one wire from the solenoid of the gas safety valve.
5. The flame should extinguish and the control will begin sparking as it begins a 40 second trial ignition.
6. After the 40 second trial ignition, the CHECK indicator should be lit and the GAS indicator will flash indicating the burner is not lit. This indicates that the gas safety valve is working properly.
7. Put the wire back on the solenoid of the gas safety valve.
8. Close the lower fresh air intake vent.
9. Turn the refrigerator off and then, after 5 seconds, turn the refrigerator back on to remove the CHECK condition.

REMOVING AND REINSTALLING THE REFRIGERATOR

This procedure should only be done by your RV dealer or an authorized Atwood service center.

1. Shut off the gas supply line at the LP tank
2. Disconnect the gas supply line at the rear of the refrigerator. ALWAYS USE two wrenches to loosen and tighten gas supply connections to avoid possible leaks.
3. Cap the gas supply line
4. Unplug the AC power cord from the receptacle in the back of the enclosure
5. Disconnect the DC input lines from the powerboard.
6. Loosen the screws anchoring the refrigerator to the enclosure in both the front and back of the cabinet.
7. Slide the refrigerator out of the enclosure.

When replacing the refrigerator, make sure that the combustion sealing strips behind the front surface of the breaker are undamaged and intact. As the refrigerator is slid into the enclosure, insure that the combustion seal is compressed uniformly all around the refrigerator between the front breaker and the edge of the enclosure. To complete the installation, follow the reverse order of the removal steps above. After making the gas connections, check all connections for leaks.



CONTROL PANEL

The refrigerator control panel is located between the fresh food and freezer compartments of your refrigerator. The refrigerator control requires +12 volts DC to operate. There are three pushbuttons.

POWER ON – Pressing this pushbutton turns the refrigerator on and off.

MODE – Pressing and holding this pushbutton cycles the mode selections from AUTO, manual GAS, and manual AC. Releasing the pushbutton selects the last mode displayed. The selected mode will be displayed for approx 5 seconds before all the mode indicators are turned off. The active mode can be displayed at any time by pressing and releasing the MODE pushbutton.

TEMP – Pressing and holding this pushbutton cycles the temperature settings from 1 through 5 with 5 being the maximum cool setting. Releasing the pushbutton selects the last temperature setting displayed. The selected temperature setting will be displayed for approx 5 seconds before all the temperature indicators are turned off. The active temperature setting can be displayed at any time by pressing and releasing the TEMP pushbutton.

AUTO MODE

When the refrigerator is in the AUTO mode, the control automatically selects the best energy source which is available. When a more efficient energy source becomes available, the refrigerator automatically switches to the more efficient source. AC energy is considered the more efficient energy source and is the first choice selected by the control. Propane gas is the second choice and is selected in the AUTO mode only when AC energy is not available.

GAS MODE

The GAS mode can be selected either automatically or manually. When switching to gas operation, the refrigerator control begins a 40 second trial ignition cycle. During this period, the control opens the gas safety valve and begins sparking the burner. If after 40 seconds the control fails to detect the presence of a flame, the control shuts off the gas safety valve and stops sparking the burner. The CHECK indicator on the control panel turns on indicating that the burner failed to ignite. The CHECK indicator can be reset by turning the refrigerator off and then back on again and a new 40 second trial ignition cycle begins. On initial start up or after changing a propane tank, it is possible that air in the gas supply lines will require 2 or 3 ignition trials before successfully lighting the burner. If after repeated attempts, the burner fails to ignite, stop and consult your local dealer or an authorized Atwood Service Center.

MANUAL MODES

The manual modes allow for selection of either the AC or GAS modes directly. If the selected mode's energy source is not available, the refrigerator is turned off, the

CHECK is turned on and the selected mode indicator flashes on and off indicating which energy source is not available.

DOOR HANDLES

The door handles latch when closed to prevent the doors from opening travel. When closing the doors, push each door into the refrigerator cabinet until you hear a distinct "click" sound which will indicate that the door is latched. To open a door, pull the handle away from the refrigerator cabinet to unlatch the handle.

During off-season storage, the handle has a storage latch which prevents the door from completely closing. Keeping the doors partially opened during long term storage prevents odors from building up in the cabinet. To engage the storage latch, open each door about 1/2 inch, hold the door handle in the open position, and push the storage latch into the cutout of the strike plate. Never use the storage latch as a travel latch because the doors will not be fully closed.

DOOR AJAR ALARM

This refrigerator has an alarm to alert you if the fresh food compartment door is left not fully closed. If the door is left open for more than 2 minutes, the CHECK light will be lit and a beeper will sound a chirp approx every 5 seconds until the door is closed. The refrigerator will continue to operate normally throughout the door ajar alarm sequence.

MOISTURE DIVIDER HEATER

This refrigerator has a heater which is automatically controlled and prevents moisture from forming on the center divider located between the freezer and fresh food compartments.

BACKUP TEMPERATURE CONTROL SYSTEM

This refrigerator has a backup temperature control system which allows the owner to have variable temperature control of the refrigerator even if the temperature sensor should fail.

If the control cannot read the temperature sensor, the control uses the selected temperature setting to control the refrigerator cycle and adjust the temperature accordingly.

THERMAL SWITCH MONITOR

This refrigerator has a thermal switch which serves as an overheating monitor.

TILT SENSOR TECHNOLOGY

This refrigerator control incorporates a patent pending tilt sensor which enables the control to constantly monitor the angle at which the refrigerator is operated. This feature is protects the user from potential hazards attributed to prolonged operation at severe angles of inclination. This monitoring function is completely invisible to the user and only becomes apparent to the user in the rare event that the refrigerator has been operated for prolonged periods of time at severe tilt angles. Normal care in leveling of your vehicle will prevent this feature from ever being noticed.

USING YOUR REFRIGERATOR

FOOD COMPARTMENT

Start up the refrigerator and let it get cool for 8 hours before loading with food.

- Cover all liquids and moist foods to decrease frosting of fins.
- Allow all hot foods to cool before loading them into the refrigerator
- Do not cover shelves with plastic to allow natural air flow inside of the cabinet
- Coldest positions inside the refrigerator are below the fins and at the bottom of the cabinet.

FROZEN FOOD STORAGE COMPARTMENT

The frozen food storage compartment is intended for storage of pre-frozen foods. It is not intended for quick freezing of warm food.

- All food items should be wrapped or in storage containers
- Ice cubes can be made in this compartment by placing the ice cube tray directly on the bottom of the compartment.

STORAGE VOLUMES

- Total refrigerated volume of HE-0801 is 8 cu ft
- Total refrigerated volume of HE-0601 is 6 cu ft

DEFROSTING

The cooling fins of the refrigerator operate at below freezing temperature and will naturally form frost from humidity which is naturally present in the air.

When the frost builds up on the fins, the frost will eventually begin to fill up the space between the fins. This is the time to defrost the refrigerator.

To defrost the refrigerator –

- Turn off the refrigerator and remove all of the food from the refrigerator and the freezer
- Leave both doors open
- Defrosting time can be reduced by putting pans of WARM water in the refrigerator and the frozen food compartments



DO NOT USE a hot air hair dryer. High temperatures can cause the inside surfaces of the refrigerator to warp or melt.

DO NOT USE a knife or ice pick or any sharp tools to remove frost. Damage to the interior of the refrigerator or perhaps the cooling system can result.

When all of the frost has melted, dry the interior of the refrigerator with a clean cloth. Replace the food and turn your refrigerator back on.

CLEANING

After defrosting the refrigerator is a good time to clean the refrigerator. The interior can be cleaned with warm water and a mild liquid dishwashing detergent.

DO NOT USE abrasive cleaners, strong chemicals, or scouring pads because they will damage the interior.

Dry all surfaces with a clean cloth before reloading the refrigerator with food.

MAINTENANCE

ANNUAL MAINTENANCE CHECKLIST

Have a qualified RV dealer or an authorized Atwood service center do these annual safety and maintenance checks.

- Examine the gas supply lines for leaks.
- Make sure the propane gas pressure is 11 inches of water column
- Make sure the combustion seal is complete and intact
- Make sure the burner and the burner orifice are clean
- Make sure the electrode spark gap is between 0.125 and 0.187 inches
- Make sure the AC voltage is between 108 -132 volts AC
- Make sure the DC voltage is between 9.0 -15.0 volts DC
- Make sure the rear of the refrigerator enclosure is free from combustible materials
- Make sure that the rear of the refrigerator enclosure provides a good ventilation path and is free from obstructions

GENERAL MAINTENANCE – FLAME APPEARANCE

While the refrigerator is operating in GAS mode, one should routinely observe the flame for proper burning characteristics.

1. Start the refrigerator in the manual GAS mode.
2. Use the TEMP pushbutton to select the maximum cool setting
3. Open the lower fresh air intake vent located behind the refrigerator
4. Careful remove the burner box protective cover and observe the flame
5. The color of the flame should be a deep blue color inside of the flame with a lighter blue color around the outside of the flame
6. The flame should be centered above the burner slots and have a constant shape with no flickering
7. The flame should not touch the inside of the flue tube located directly above the flame
8. Assuming the flame appearance is correct, reinstall the protective cover on the burner box, close the lower fresh air intake vent and return the refrigerator to the previous mode and temperature setting.

Clear blue color of flame

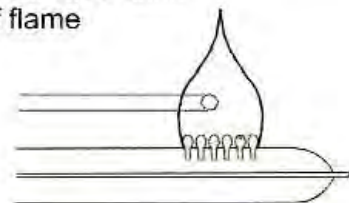

If the flame appearance is not correct (e.g. the flame is yellow or the shape is constantly changing and/or flickering or if the flame is touching metal surfaces inside the burner box – do not use the GAS mode and contact your dealer or authorized Atwood service center.

TROUBLESHOOTING

REFRIGERATOR IS NOT COOLING PROPERLY

1. **Burner orifice clogged**
Cleaning procedure pg. 7
2. **Check level of refrigerator**
3. **Venting problem**
Remove obstruction in air flow behind cabinet
4. **Heavy frost buildup on cabinet fins**
Defrost procedure pg. 7
5. **Flue baffle not inserted properly in flue tube**
6. **Burner dirty**
Clean burner
7. **LP gas pressure low at burner**
Set main vehicle regulator to deliver 11" wc.
8. **Burner not located properly under flue tube**
Relocate.
9. **Burner damaged**
Replace
10. **Odor from fumes**
 - Dislocated burner
 - Damaged burner
 - Dirty flue
11. **Fuses**
 - Refrigerator AC supply
 - Refrigerator Control – Powerboard



CAUTION

The refrigerator shelves are equipped with safety shelf clips which are intended to prevent children from removing the shelves and creating a possible safety hazard.

The shelves can be rearranged by removing the clips, repositioning the shelves as desired and reinstalling the clips. The shelves should never be positioned to allow a space greater than 2 cu ft (or 60 liters) between any two shelves.

ERROR MESSAGES

INDICATOR	DESCRIPTION	REMEDY
CHECK light Slow beep Once every 2 sec	Door Not Closed	Close Door
CHECK light Very Slow beep Once every 10 sec	Back Up Operating Mode Thermister damaged	Replace thermister when convenient
Temp Set LEDs all flash when MODE switch is pressed	Back Up Operating Mode Thermister damaged	Replace thermister when convenient
CHECK light GAS light on	Burner failed to light	Retry
CHECK light GAS light flashing	Gas unavailable	Connect gas
CHECK light AC light flashing	AC unavailable	Connect AC
CHECK light, AUTO light, AC light All on	1. Open DC fuse 2. Open thermal switch 3. Prolonged operation in severe tilt position	1. Replace fuse 2. Contact service 3. Contact service

